

Features

- 1.0 INCH DIGIT HEIGHT.
- LOW CURRENT OPERATION.
- EXCELLENT CHARACTER APPEARANCE.
- HIGH LIGHT OUTPUT.
- EASY MOUNTING ON P.C. BOARDS OR SOCKETS.
- I.C. COMPATIBLE.
- MECHANICALLY RUGGED.
- STANDARD : GRAY FACE, WHITE SEGMENT.
- RoHS COMPLIANT.

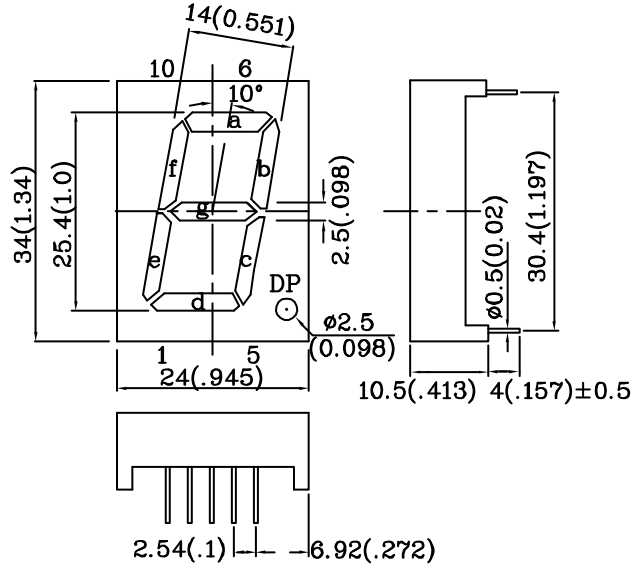
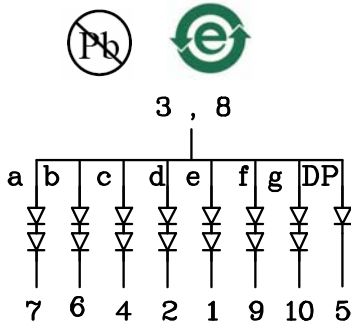

Notes:

1. All dimensions are in millimeters (inches).
2. Tolerance is ± 0.25(0.01") unless otherwise noted.
3. Specifications are subject to change without notice.

Absolute Maximum Ratings (TA=25°C)		MR (GaAlAs)	Unit
Reverse Voltage Per Segment or (DP)	V _R	10(5)	V
Forward Current Per Segment or (DP)	I _F	30(30)	mA
Forward Current (Peak) 1/10 Duty Cycle 0.1ms Pulse Width Per Segment or (DP)	i _{FS}	155(155)	mA
Power Dissipation Per Segment or (DP)	P _T	150(75)	mW
Operating Temperature	T _A	-40 ~ +85	°C
Storage Temperature	T _{stg}	-40 ~ +85	
Lead Solder Temperature [2mm Below Package Base]	260°C For 3~5 Seconds		

Operating Characteristics (TA=25°C)		MR (GaAlAs)	Unit
Forward Voltage (Typ.) Per Segment Or (DP) (I _F =10mA)	V _F	3.6(1.8)	V
Forward Voltage (Max.) Per Segment Or (DP) (I _F =10mA)	V _F	5.0(2.5)	V
Reverse Current (Max.) Per Segment Or (DP) (V _R =10(5)V)	I _R	10(10)	µA
Wavelength Of Peak Emission (Typ.) (I _F =10mA)	λ _P	660	nm
Wavelength Of Dominant Emission (Typ.) (I _F =10mA)	λ _D	640	nm
Spectral Line Full Width At Half-Maximum (Typ.) (I _F =10mA)	Δλ	20	nm
Capacitance (Typ.) (V _F =0V, f=1MHz)	C	45	pF

Part Number	Emitting Color	Emitting Material	Luminous Intensity (IF=10mA) ucd		Wavelength nm λ P	Description
			min.	typ.		
DMR25A	Red	GaAlAs	12000	59990	660	Common Anode, Rt. Hand Decimal

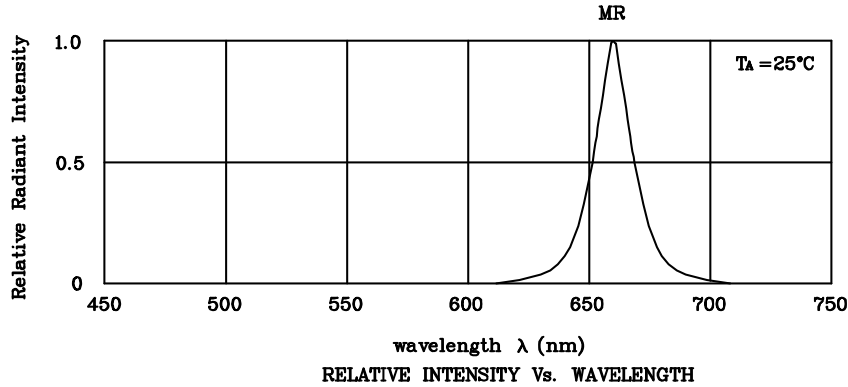

❖ MR

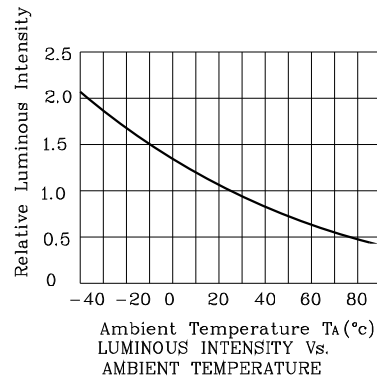
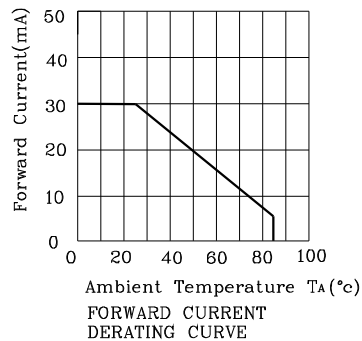
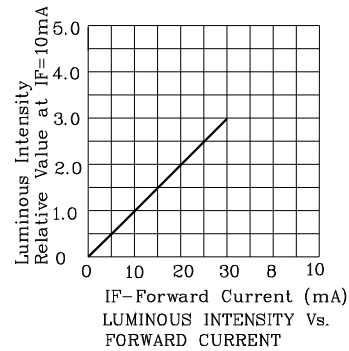
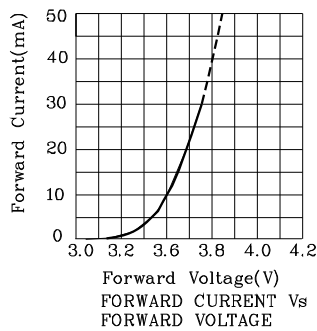

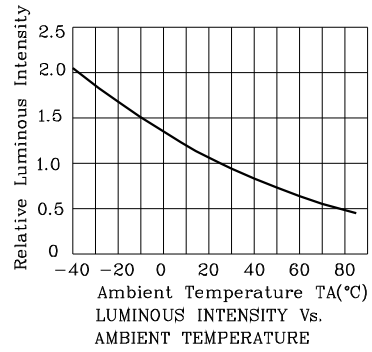
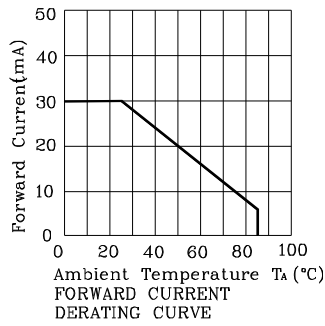
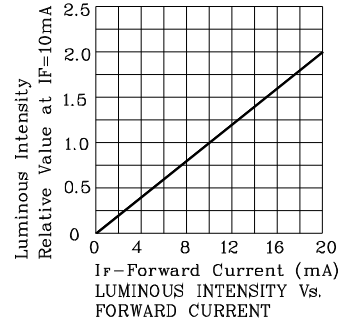
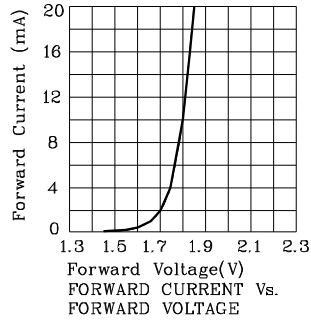

Wave Soldering Profile For Lead-free Through-hole LED.

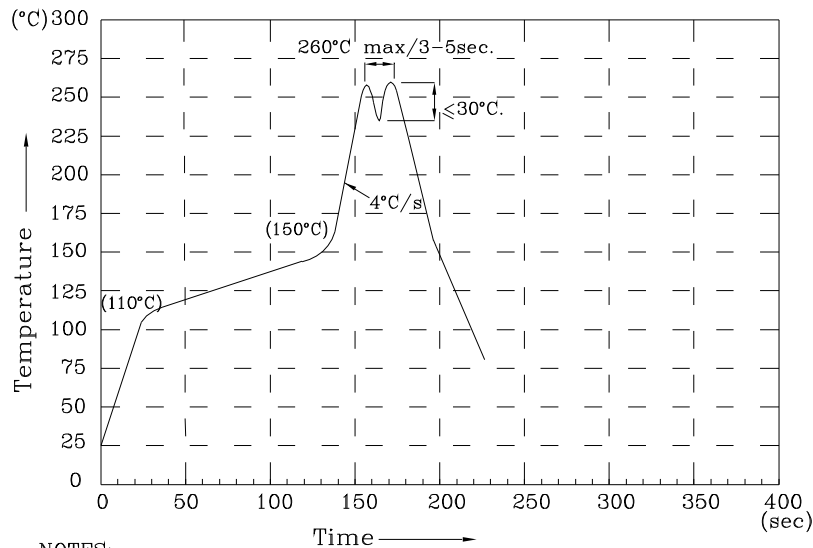

NOTES:

1. Recommend the wave temperature 245°C~260°C. The maximum soldering temperature should be less than 260°C.
2. Do not apply stress on epoxy resins when temperature is over 85 degree°C.
3. The soldering profile apply to the lead free soldering (Sn/Cu/Ag alloy).
4. No more than once.

Remarks:

If special sorting is required (e.g. binning based on forward voltage, Luminous intensity / luminous flux, or wavelength), the typical accuracy of the sorting process is as follows:

1. Wavelength: +/-1nm
2. Luminous intensity / luminous flux: +/-15%
3. Forward Voltage: +/-0.1V

Note: Accuracy may depend on the sorting parameters.

PACKING & LABEL SPECIFICATIONS

DMR25A

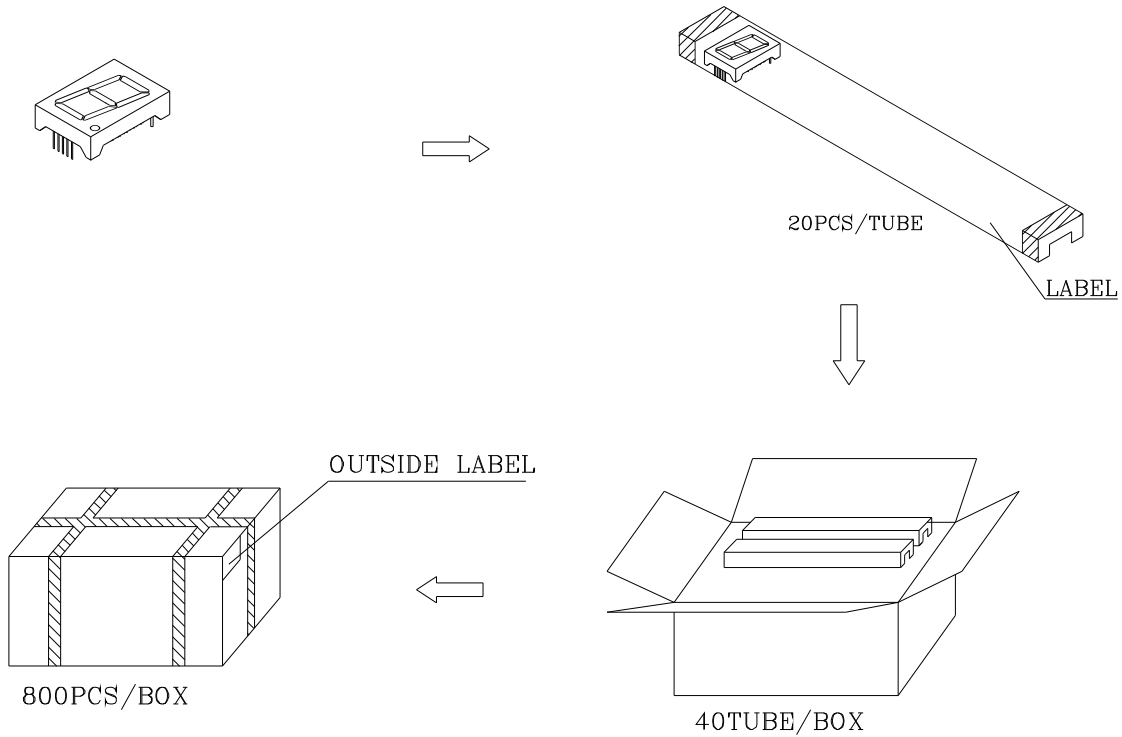

Inside LABEL Paste On The IC-tube

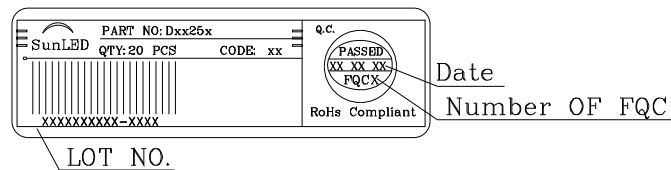

Outside LABEL Paste On The Box

